

3DISC

Heron™ IOS

User Manual



Version 3.4

Document	Product Version	Document Version	Date
Heron™ IOS User Manual IOS-FPM-71-001	1.0	Initial Release	08.01.2018
	2.0	1.0	10.01.2019
	3.0	2.0	01.01.2020
	3.4	3.0	09.20.2021

HeronTM IOS

THE BEAUTY OF SIMPLICITY

1. Introducing the Heron™ IOS	6
1.1 Introduction	6
1.2 Indications supported	6
1.3 Certification and compliance	6
1.4 Regulatory	7
1.5 Intended Use	7
1.6 Classifications	7
2. What's in the Box	8
2.1. Components Overview	8
3. System Requirements and Specifications	9
3.1 System Specifications	9
3.1.1 Scanner Specifications	9
3.1.2 Scanning Process	9
3.1.3 Software output and design software compatibility	10
3.2 Computer Requirements	10
3.3 Environment Conditions	11
3.4 Power Input	11
3.5 Reusable Tips	11
3.6 Scanner Docking Base and Handpiece	11
3.7 Calibration	12
3.8 Wall Mount Installation Instructions (Optional)	12
4. Setting up the Heron™ IOS Solution	13
4.1 Connecting Heron™ IOS	13
4.2 Launching HeronClinic™	15
4.2.1 Setting Up A HeronClinic™ User Account	15
4.2.2 Connecting Heron™ IOS To HeronCloud™	16
4.3 Getting Started With HeronClinic™	17
4.4 Configuring HeronClinic™ Settings	19
5. Using HeronClinic™	25
5.1 Managing Patient cases	25
5.2 The HeronClinic™ Scan Workflow	27
5.3 Before You Scan	31
5.3.1 Operating the scanner	31
5.3.2 Using the Scanner Tip	32
5.3.3 The Scanning Live View	33
5.3.4 Default Scan Workflow	34
5.4.1 Scanning the Maxillary Arch	34
5.4.2 Scanning the Mandibular Arch	36
5.4.3 Timing scans	37

5.4.4	Using the Quality Map tool.....	37
5.4.5	Bite Alignment	38
5.4.6	Auto-Realignment.....	41
5.4.7	Using Bite Alignment Tools.....	42
5.4.8	Finalizing A Patient Case.....	43
6.	Communicating With Labs	45
6.1	Linking a HeronClinic™ account to HeronCloud	45
6.2	Configuring a Connection with a Lab in HeronCloud.....	46
6.3	Managing Case Details in HeronCloud.....	47
6.4	Configuring HeronCloud Settings	48
7.	Maintenance	50
7.1	Cleaning the Handpiece	50
7.2	Cleaning and Sterilization of Tip.....	50
7.3	Disposal	52
7.4	Calibration	52
8.	Safety Guidelines and Warnings.....	53
8.1	Warnings and Symbols.....	53
8.2	General Guidelines	53
8.3	General Warnings	54
8.3.1	System Modification	54
8.3.2	Approved Software	54
8.3.3	Equipment Failure.....	54
8.4	Mechanical Hazards	54
8.4.1	Moving Parts	54
8.4.2	Dropped Equipment.....	55
8.4.3	Base	55
8.5	Electrical Safety.....	55
8.5.1	Electrical Shock	55
8.5.2	Stress on Cables	55
8.6	Eye Safety	56
8.7	Hygiene.....	56
8.8	During Systems Operation	57
8.9	EMC Guidance and Declaration	57
9.	Support, Warranty and RepairService.....	64
9.1	Support.....	64
9.2	Standard Warranty	64
9.3	Repair Service	64
9.4	Out of Warranty RepairService.....	65

1. Introducing the Heron™ IOS

1.1 Introduction

Thank you for purchasing the Heron™ IOS solution from 3DISC. The Heron™ IOS solution is designed and developed to produce high-quality digital intraoral scans or models, for dental restoration or analysis.

The Heron™ IOS solution is designed with you as a dentist and your patient in mind. The scanner is lightweight, small and easy to use, enabling fast, accurate scanning and great patient experience. The Case management application provides efficient and customizable order management, for easy and intuitive use. Enjoy your new intraoral scanner solution!

1.2 Indications supported

The data sets from the Heron™ IOS can be used for the following indications.

- Conventional crowns
- Anatomic crowns
- Copings
- Provisional crowns
- Anatomical pontics
- Reduced pontics
- Provisional pontics
- Inlays/Onlays
- Implant abutments
- 3-unit implant bridges
- Up to 5-unit bridges
- Orthodontic aligners
- Nightguards
- Splints
- Retainers
- Bleach trays
- Sleep appliances
- ...

* Verify with your dental lab or service provider about their capabilities to produce particular indications.

1.3 Certification and compliance

The system has been tested and conforms to the following standards:

- IEC 60601-1, Medical electrical equipment - Part 1: General requirements for basic safety and essential performance
- IEC 60601-1-2, Medical electrical equipment - Part 1-2: General requirements for basic safety and essential performance - Collateral Standard: Electromagnetic disturbances
- Requirements and tests:
- IEC 62471, Photobiological safety of lamps and lamp systems

1.4 Regulatory

The Heron™ IOS is manufactured and marketed in accordance with US FDA Regulations and EU Medical Device Regulation 2017/745.

1.5 Intended Use

The Heron™ IOS is an optical impression system. It is used to record the topographical characteristics of teeth, dental impressions, or stone models for use in the computer-aided design (CAD) and computer-aided manufacturing (CAM) of dental restorative prosthetic devices.



CAUTION: Rx only - Federal law restricts this device to be sold by or on the order of a Dentist.



WARNING: Unintended use of the system can result in physical injury to the patient and operator, and damage to the system.

1.6 Classifications

The Heron™ IOS system has the following classifications

- Protection against electrical shock: Type B Applied Part
- Protection against harmful ingress of water: Ordinary equipment (IPX0)
- Safety of application in the presence of a flammable anesthetic material with air or with oxygen or nitrous oxide: Equipment not suitable for use in the presence of a flammable anesthetic mixture with air or with oxygen or nitrous oxide.

2. What's in the Box

The Heron™ IOS system includes the following:

Name

Heron™ IOS System (Includes 3 Tips)

USB 3.0 Cable

AC/DC Power Adapter

Part Number

IOS-FP-71-001

IOS-CP-00-043

IOS-CP-00-088

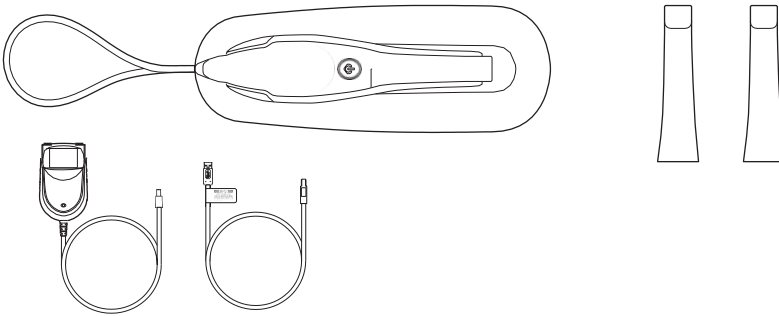

Save the Box: It is highly recommended that you store the box in a safe place and do not dispose of it. The box is optimal for any necessary transportation or shipment of the Heron™ IOS.

2.1. Components Overview

The Heron™ IOS is comprises the following components:

1. Docking base
2. Tip
3. Scan Button
4. Scanner handpiece
5. USB 3.0 Cable
6. AC/DC Power Adapter

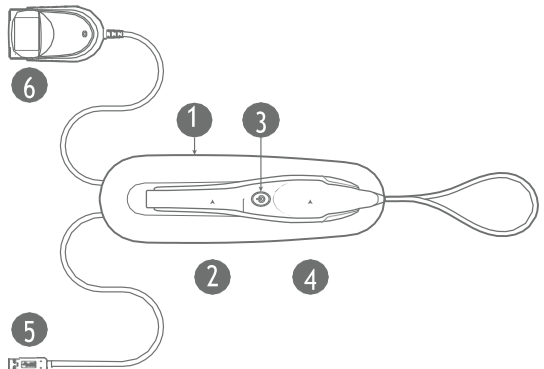

3. System Requirements and Specifications

3.1 System Specifications

3.1.1 Scanner Specifications

Scanner Type	Hand-held (chairside) scanner that creates optical impressions for dental restorations.
Design	Compact, lightweight, ergonomic – designed to be operated with little physical effort.
Dimensions Base	Size: L 306mm, W 98mm, H 72mm
Dimensions Scanner	Weight: 150 grams
	Size: L 256mm, W 43mm, H 43mm
Power Requirement	DC5.0V / 4A (Power supply included)
Scanner Tip	Reusable, sterilize using steam autoclave
Heating Element	Prevents formation of fog on the optics
Acquisition Method	Intraoral camera – active stereo imaging
Color Scanning	24-bit (8-bit per channel)

3.1.2 Scanning Process

Tooth Preparation	No powder or spray required
Scanning Principle	Continuously scanning and accumulating (stitching) depth and color data
Distance Scanner - Tooth	0 – 14mm
Possible contact duration by operator	<10 min. Note: May vary with hardware configuration
Operator accessible part	Handpiece
Possible contact duration by patient	10 min ≤ t
Patient accessible part (Type B Applied Part)	Tip
Computer – Scanner Interface	USB 3.0

3.1.3 Software output and design software compatibility

Output File Format	STL, PLY, OBJ
Compatibility with CAD/CAM Systems	Open Architecture Output format STL, PLY, OBJ Compatible with most Dental CAD systems

3.2 Computer Requirements

Required Software and Misc.

Operating System	Windows 10 (Excluding Windows 10 S, now defunct) Administrative rights required
Disk Space	100 GB of free disk space or greater
Ports	1 x USB 3.0 port (SuperSpeed)

Required Hardware

CPU Type	Intel i7 - 4 Cores or greater (e.g. i7 8700)
CPU Clock	2.8 GHz clock or greater
Memory	16 GB of RAM or greater (DDR4 or better)
GPU	NVIDIA GeForce Graphics Processor 10 Series (GTX): 1070 or Greater 10 Series (GTX): 1070 or greater - At least 6 GB video memory RTX2000 Series: 2060 or greater - At least 6 GB video memory Quadro RTX3000 and above for laptop - At least 6 GB video memory



NOTE: AMD GPUs are NOT compatible with the Heron™ IOS.
Not meeting minimum hardware requirements will affect the performance of the scanner.

3.3 Environment Conditions

Operating Temperature	10°C to 40°C
Operating Relative Humidity	10% to 80% (non-condensing)
Storage Temperature	- 20°C to 60°C
Storage Relative Humidity	10% to 80% (non-condensing) Indoor use only
Installation Category	1
Pollution Degree	2
Ingress of Liquids	IPX0
Protective Class	Class IIIb
Overvoltage category	II per IEC 60664-1
Max. working condition	Continuous cycles with image capture and transmission from/to Notebook or non-medical grade PC.
Other possible accessories (IEC60601-1 3rd, Cl. 16)	Notebook with AC/DC Adapter.
Equipment Maintenance	No user maintenance is required, and no user service is allowed. Please contact technical support in case of problem.
Cleaning	Do not try to clean the inside of the device. Refer to Chapter 6 for cleaning and sterilization.

3.4 Power Input

The power adapter input is 5V DC, 100-240V AC, 50-60Hz.

3.5 Reusable Tips

Scanner tip is autoclavable up to 250 times in a steam autoclave when used with 132°C/134°C 4 mins cycle or 121°C 45 min cycle. See section 7.2 below.

3.6 Scanner Docking Base and Handpiece

The scanner body consists of the Docking Base and Handpiece, which are connected by a flexible, non-detachable cable.

3.7 Calibration

The Heron™ IOS™ is factory calibrated. In the case of calibration issues due to transport, please contact your reseller or 3Disc support technician.

3.8 Wall Mount Installation Instructions (Optional)

When wall mounting the scanner's base, be careful to respect measurements indicated to drill holes for the wall mount.

- It is recommended to use wall anchors and threaded screws with a 8mm (5/16th inch) head diameter.
- A 4-5mm (3/16th in) distance between wall and bottom screw head is recommended.

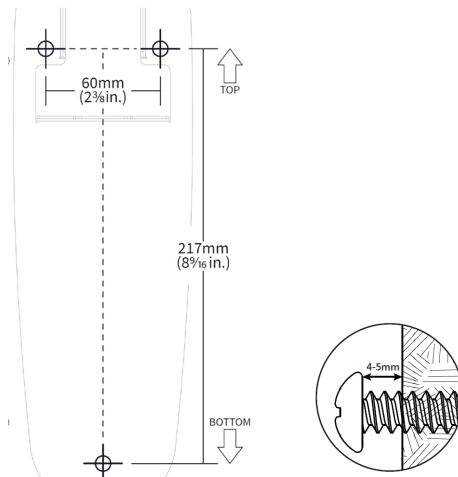

Caution: If the docking base is not properly installed there is a possibility of the base falling and damaging the scanner.



IMPORTANT: 3DISC is not responsible for accidents or damage caused in the event the scanner falls.

4. Setting up the Heron™ IOS Solution

4.1 Connecting Heron™ IOS

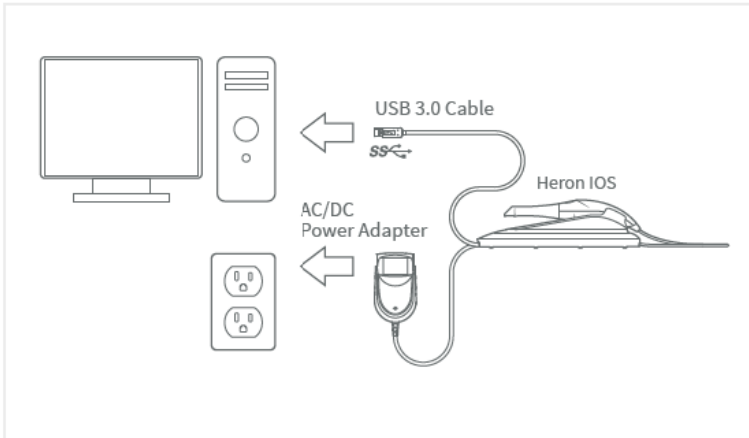

Installing and connecting the Heron™ IOS Solution

To install and connect the Heron™ IOS Scanner:

1. Place the docking base on a flat, stable surface and place the Heron™ IOS handpiece securely on the base.
2. Connect the AC/DC power adapter cable to the docking base (the connector socket is located underneath the base).
3. Connect the provided USB 3.0 cable to the docking base (the connector socket is located underneath the base).



NOTE: Using a USB cable other than the one provided may result in system malfunction or reduced performance.

4. Connect the other end of the USB cable to the computer.



NOTE: It is strongly recommended to plug the USB cable to a USB port located at the back of the computer; not doing so may result in system malfunction or reduced performance.



Make sure to use a USB port that is compatible with USB 3.0 (SuperSpeed), usually indicated by the symbol: not doing so may result system malfunction or reduced performance.

5. Connect the AC/DC power adapter to a power outlet.



WARNING: Unsuitable installation sites:

- Locations with excessive humidity or dust
- Locations subject to high temperature
- Locations subject to shaking or vibration
- Locations exposed to considerable electrical or magnetic noise, or other forms of electromagnetic energy



IMPORTANT: If using a laptop computer, make sure the power supply is connected to an outlet and not running on battery power. Failure to do so will mean that the scanner will not have sufficient power to produce images.

4.2 Launching HeronClinic™

Once you have connected the Heron™ IOS, you are ready to launch the HeronClinic™ software installed on your computer.

On the computer, click on the HeronClinic™ desktop icon to launch HeronClinic™ software.



the

On first launch, the HeronClinic™ Startpage will display a default HeronClinic™ **User Account (HC)**.

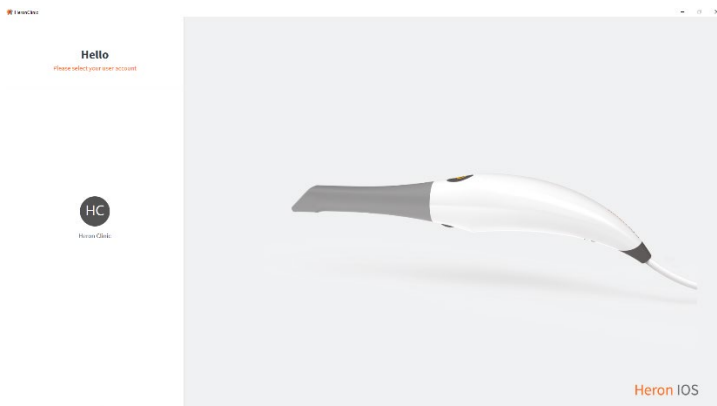

4.2.1 Setting Up A HeronClinic™ User Account

Before using the scanner, use the default HeronClinic™ (administrator) account to setup your HeronClinic™ **User** account:

1. Click the **System** icon located in the top right-hand corner of the HeronClinic™ interface. This will open the **Settings** interface.
2. Select **Users** in the left-hand **Settings** menu, and click on **Add and Edit Users**.
3. Select the default Heron Clinic **User profile**, and click on the **Edit** icon.

In **Users** settings you can Add or Edit Users, and enter/modify User information: email, name and photo.

User dossiers can be password protected, and linked to a HeronCloud™ account.

4.2.2 Connecting Heron™ IOS To HeronCloud™

The Heron™ IOS Solution enables users to connect to its dedicated cloud platform **HeronCloud™**, to easily and efficiently setup and manage file transfers and connections with labs.

If you select **Use HeronCloud™** in the **Add or Edit Users** dialog box, the **HeronCloud™ Login** window will open automatically, inviting you to **Login** or to **Create a New Account**.

For information on setting up a HeronCloud User Account and Connection see [Creating A HeronCloud™ User Account](#) and [Communication with the Lab](#) below.

4.3 Getting Started With HeronClinic™

Using the HeronClinic™ Start Screen

When you login to HeronClinic, the Patients or Cases default view is displayed (selected in settings).

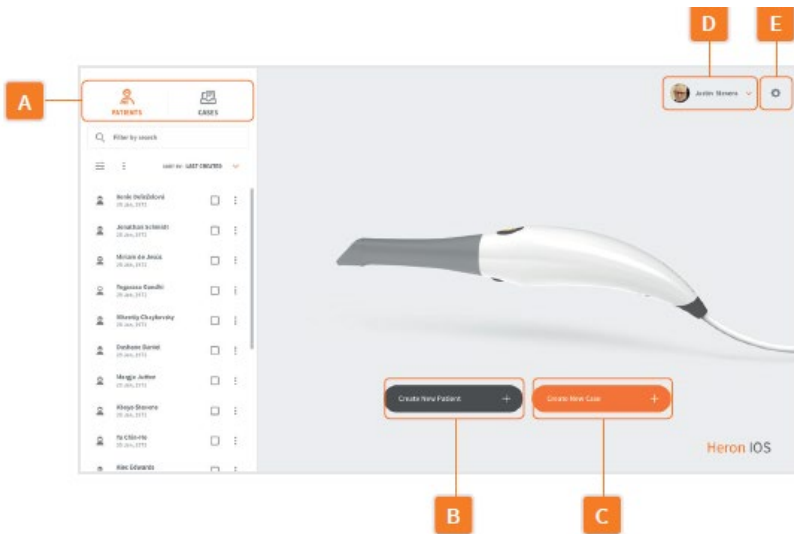

A. Patients/Cases View

You can toggle between **Patients** and **Cases** views, and Filter or search desired Patients/Cases.

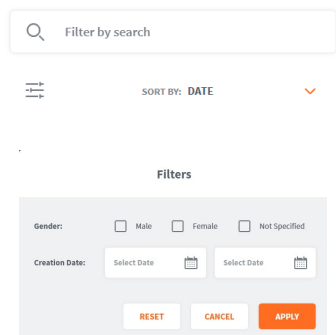

Filter/Search

Search by term or Click on the Filter icon

 to open the Filters dialog box.

You can filter by Gender and/or Date.

B. Create new patient

Select the **Create New Patient** click bar to create a new patient profile and add the new patient to the system database.

- Click to open the Create New Patient dialog box.
- A Patient ID will be auto-generated. This can be edited as required.
- Enter Patient details and any useful medical notes.
- Click to Create.

C. Create new case

Click on the Create New Case click bar to directly access the Order Form window in the Heron™ IOS Scanning module menu.



See the **Heron™ IOS Scanning Workflow**: below.

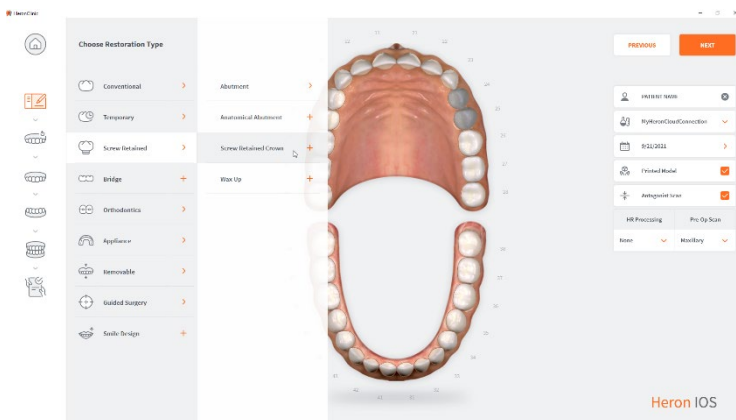

It is recommended you add a new Case by first selecting a Patient. See [Adding a new Case to a Patient](#) below.

D. User Logout

Click here to logout or select a new user.

E. Settings

Click here to access system settings.

4.4 Configuring HeronClinic™ Settings

Settings Menu

System settings can be accessed by clicking the System icon located in the top right-hand corner of the HeronClinic™ interface.



Settings

General

Data

Sounds

Users

Upload

Order Form

PDF

The screenshot shows the HeronClinic™ Settings interface. At the top, there is a search bar labeled "Filter by search". Below it, the "General" section is expanded, displaying a list of settings:

Setting Name	Value	Action
System Language	English	Dropdown arrow
Preferred Output Format	.STL	Dropdown arrow
Picture Save Format	.PNG	Dropdown arrow
Preferred Start Page	Recent Patients	Dropdown arrow
Enable Direct Scan Workflow	<input checked="" type="checkbox"/>	Toggle switch
Enable Quality-Based Transparency	<input checked="" type="checkbox"/>	Toggle switch
Enable Colored ROI Overlay During Bite Alignment	<input checked="" type="checkbox"/>	Toggle switch
Enable High-Resolution Finalization	<input checked="" type="checkbox"/>	Toggle switch
Software Version	3.4.0902.4	Copy icon
UI Version	3.0.12.5	Copy icon
Check for Software Updates	<input type="button" value="CHECK NOW"/>	Check for updates button
User Manual		Link icon
Teamviewer		Link icon
Support Page		Link icon

To access a specific Settings group, you can select from the left-hand Settings Menu, filter by search or scroll down.

Note: System settings are automatically applied to all users.

Description

System Setting	Description
System Language	Select graphical interface language
Preferred Output Format	Select default 3D Output format: STL, PLY, OBJ
Picture Save Format	Select default image format: .PNG, .JPG
Preferred Start Page	Select Recent Patients or Recent Cases default start page
Enable Direct Scan Workflow	Select to enable direct access to the Scan workflow via the Start Scanning button in the Start Screen.
Enable Colored ROI Overlay During Bite Alignment	Select to display colored ROI overlay during Bite Alignment. Activated by default. This triggers a green/red overlay during scan phase to indicate actively gather data.
Enable High-Resolution Finalization	Select to enable default high-resolution finalization
View Software version (copy function to right)	Select to view/copy scanning module software version
UI Version (copy function to right)	Select to view/copy user interface version
Check for Software Updates	Click Check Now button to manually check for software updates. An automatic check is done at launch
User Manual	Click to access User manual online
Teamviewer	Click to allow secure remote control of your workstation by a 3Disc support technician.
Support Page	3DISC support homepage.

Data Settings

Data settings enable you to specify Import and Export Database and Export Path settings. You can also choose to share or restrict access to the Database.

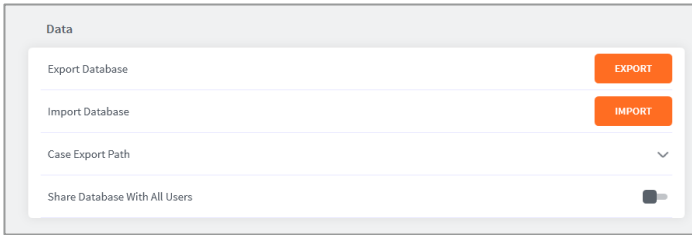

Description

Data Setting	Description
Export Database	Click on the EXPORT button to select the HeronClinic™ Data folder and Export folder , and to export All or Selected Cases
Import Database	Click on the IMPORT button to select the HeronClinic™ Data folder and Import folder , and to import All or Selected Cases
Case Export Path	Click to specify the Case Export folder
Share Database With All Users	Activate this feature to share or restrict Database access

Export Database

Click on the **EXPORT** button to select the **HeronClinic™ Data folder** and **Export folder**. You can export **All** or **Selected Cases**.

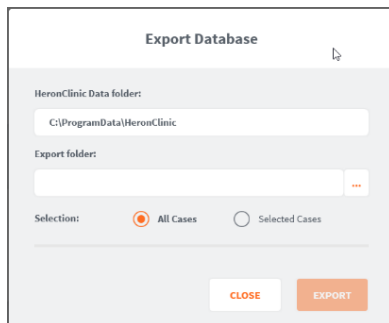

Import Database

Click on the **IMPORT** button to select the **HeronClinic™ Data folder** and **Import folder**. You can import **All** or **Selected Cases**.

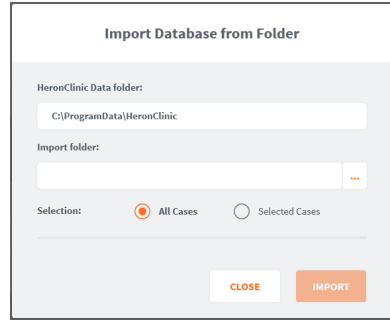

Sound Settings

Sound settings enable you to activate/deactivate the Sound Guidance feature during scanning, and to preselect sound effects and volume. The sound setting configure the sound from the computer. Note: if the computer's volume is deactivated or muted the user will not hear the sounds.

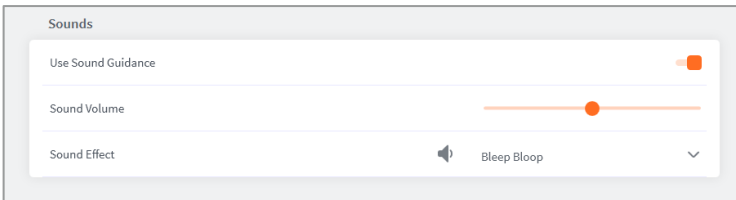

Description

Sound Setting	Description
Use Sound Guidance	Activate to use Sound Guidance during scanning (Recommended)
Sound Volume	Preselect volume
Sound Effect	Preselect sound effect

User Settings

In User settings you can Add or Edit Users using the administrator account (HC).

User dossiers can be password protected, and linked to a HeronCloud account.

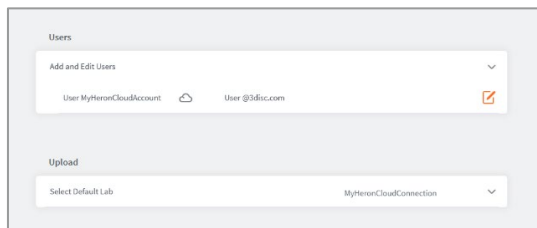

Add And Edit Users

Click the right-hand Edit icon to enter/modify User information: email, name and photo.

Select Use Password to password protect the User account.

Select Use HeronCloud to link to a HeronCloud account.

Upload Settings

The Upload setting enables users to select a default lab to transfer files to in their HeronCloud account.

Order Form Settings

Order Form settings enable you to adapt Order forms to specific ordering, restoration, implant and patient requirements.

Description

Order Form Setting	Description
Teeth Numbering System	Select order form teeth numbering system
Shade System	Select order form Shade System
Hide Patient's Name	Activate this feature to anonymize patient identity. This can be useful to protect patient privacy and to use anonymous case examples for training and presentation purposes.
Edit Restorations	The Restoration Editor enables users to customize Restoration types and materials available when filling out Case order forms.
Edit Implants	The Implants Editor enables users to Customize the Manufacturers, Systems and Connection types that are available when filling out order forms.

Customizing Restorations

Click the Edit button to open the Restoration Editor.

The Restoration Editor enables users to select/deselect Restoration types and materials available when filling out Case order forms.

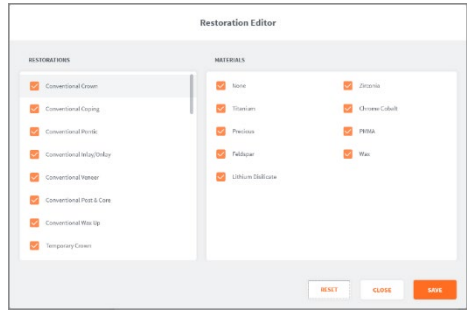

Customizing Implants

Click the Edit button to open the Implants Editor.

The Implants Editor enables users to customize the Manufacturers, Systems and Connection types that are available when filling out order forms.

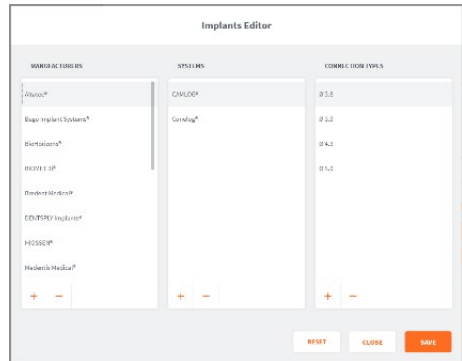

Add To/Delete From Implants Library

Elements may be added to or deleted from the Implants library by clicking on the icons at the base of each column.

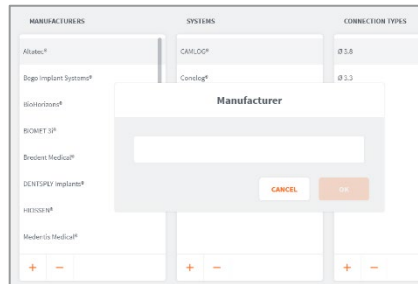

Custom Order Settings

These System settings enable users to customize Order forms for use by their organization, by adding the name, address and corporate logo, and selecting a page format.

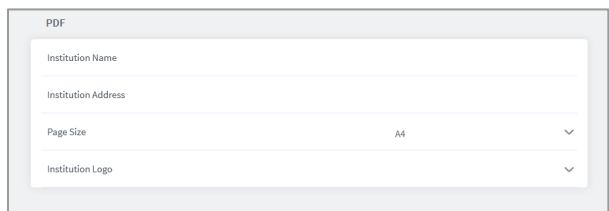

5. Using HeronClinic™

5.1 Managing Patient cases

Previewing Patient Cases

Select a Patient profile in the left-hand column of the Case Management interface to preview cases already linked to a patient.

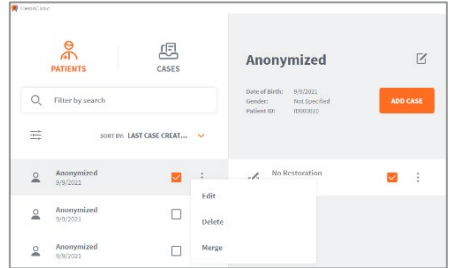

Edit, Delete or Merge a Patient profile

It is possible to Edit, Delete or Merge a Patient profile by clicking on the icon to the right of the Patient name.

Note: only patient profiles with no cases can be deleted, so any cases linked to the patient must be deleted first. Multiple cases can be deleted simultaneously.

You can also edit a Patient profile by clicking on the Edit icon  in the Patient preview.

Anonymizing Patient Data

You can anonymize patient data before sending an order by selecting **Hide Patient's Name** in system **Order Form** settings. This can be useful to protect patient privacy, and to use anonymous case examples for training and presentation purposes.

Merging a Scan with a Patient profile

A Direct Scan can be linked to an existing Patient profile by clicking Merge and selecting a case.

Adding a New Case to a Patient

Click Add Case in a selected Patient preview window to add a new case to the patient profile.

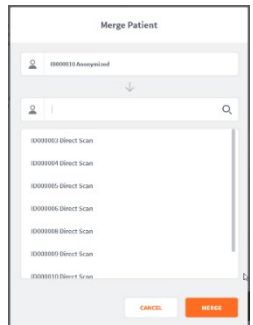

Creating a New Case

Click **Create New Case** in the HeronClinic™ Start screen, to create a new case.

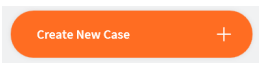

Accessing the Order Form window

Adding or Creating a new case automatically opens the Order Form window, and the icon is highlighted in the HeronClinic™ Scanning Workflow menu.



Opening a Case

When you select an already existing patient case and click Open Case, the HeronClinic™ Scanning workflow will open at the step in the Scanning workflow last worked on.



Cloning a case

It is possible to duplicate an existing case and all associated data, including order form, scan data, intraoral photos, and attachments.

- To clone a case, click and select the Clone option as shown.

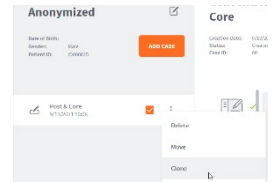

HeronClinic™ Direct Scan

It is possible to skip the Order Form step and directly access the Heron™ IOS Scanning module. To do so, select the **Start Scanning** click bar in the HeronClinic™ Start screen.

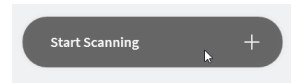

Note: *This feature is not available by default. To activate click **Enable Direct Scan Workflow** in System Settings.*



5.2 The HeronClinic™ Scan Workflow

The following walkthrough shows the typical steps and options available in the HeronClinic™ Scan Workflow.

1. Create a New Case

Click **Create New Case** in the HeronClinic™ Start screen, or select a patient and in the Preview window click **Add Case**:



This opens the HeronClinic™ **Order Form** window.

2. HeronClinic™ Scan Workflow Menu

When you open the **Order Form** window, the **Order Form** icon is highlighted in the HeronClinic™ Scan Workflow Menu.

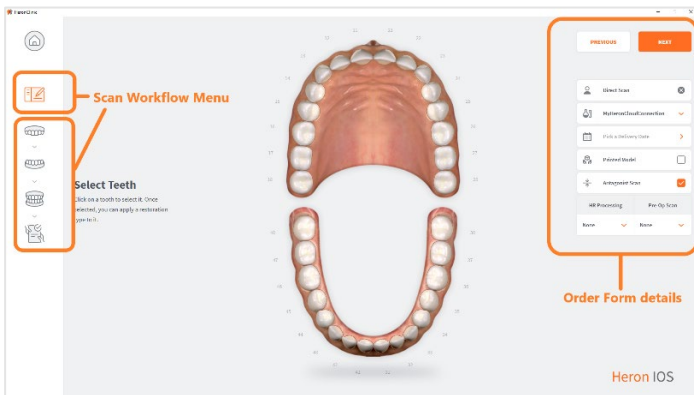

The left-hand **Scan Workflow Menu** will adapt automatically to the Restoration Type(s) selected for the current patient case.

3. Enter Order details

Order Form details for the patient case are displayed on the right-hand side of the screen.

Order Form details	Description
Patient ID	Patient Name or Anonymized ID
HeronCloud™ Connection	Connection to lab configured in the HeronCloud.
Delivery Date	Requested order delivery date
Printed Model	Order a printed model
Antagonist Scan	Include a scan of the opposing teeth (selected by default)
HR Processing	Use High Resolution processing
Pre-Op Scan	Include a pre-operative scan

The antagonist can be de-selected if not required. Relevant Scan Flow steps will be automatically removed from the Scan Flow menu.

To select a lab, a connection must first be set up with the lab via the HeronCloud platform. See: [Connecting Heron™ IOS To HeronCloud™](#).

You can select a default lab from those connected to your HeronCloud account in system [Upload Settings](#).

💡 Before sending an order, make sure the correct Patient ID and Lab are selected, and that you have entered the requested delivery date from the Lab.

4. Select tooth/teeth for restoration

- Click on the tooth or teeth to select for restoration. The **Choose Restoration Type** menu displays automatically.

Selecting a bridge:

- To select teeth to be bridged: select a tooth and then **Hold [CTL]** to select a second tooth.

Bridged teeth are displayed as shown.



5. Choose Restoration Type

- Click on a **Restoration Type** in the left-hand menu: options available for the selected restoration type are displayed automatically.

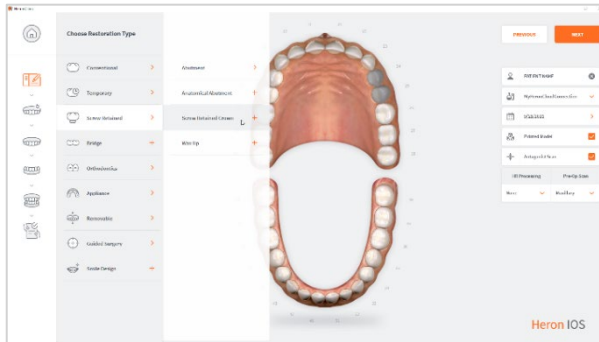

- Select the Restoration Type: the tooth to which the restoration is applied is highlighted in blue/green.

To change the selected restoration type:

- Right-click on the selected tooth to delete and then select another restoration type.

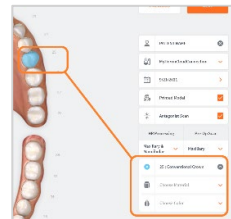

Available restoration options for the selected Restoration Types are displayed in the right-hand **Order Form** menu.

6. Select Restoration Options

- Select Restoration options for the chosen Restoration type in the right-hand Order Form menu:

Restoration options	Description
Manufacturer	Manufacturer Name
Type	Manufacturer Restoration solution
Size	Restoration model size
Material	Printed model material
Color	Shade System

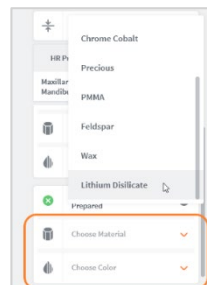

You can customize Order Forms to specific ordering, restoration and patient requirements in system **Order Form Settings**.

Example Scan Workflow Menu

In the example shown opposite, based on the selected Restorations, the Scan Workflow indicates 6 steps.

1. Pre-Op Scan

Used to integrate pre-operative scans in the scan workflow.

2. Maxillary Scan

To carry out a scan of the Maxillary arch.

3. Scan body (Maxillary)

Integrates a scan body step of the maxillary arch in the scan workflow.

4. Mandibular Scan

To carry out a scan of the Mandibular arch.

5. Scan body (Mandibular)

Integrates a scan body step of the mandibular arch in the scan workflow.

6. Bite Alignment

This step enables the user to carry out an automatic or manual bite alignment.

To begin scanning, click on the first step in the Scan Workflow Menu.



5.3 Before You Scan

Before scanning, take time to familiarize yourself with the Scanning tools and features available in the Heron™ IOS solution and the HeronClinic™ interface.

5.3.1 Operating the scanner

Start Scan

To begin scanning, press the Start/Stop button on the top of the scanner, or click the Start/Stop icon in the right-hand **Scanning Tools** menu.



	Scanning Tools
	Start Scan Start/pause scan.
	Reset Reset will delete the current scan and associated files.
	Adjust Zoom level You may change the zoom level.
	Center Scan on Screen Moves the scan to the center of the screen for ease of use.
	Color-Based Quality Map Toggles between color/grayscale display and Quality Map. The Quality Map feature enables the user to assess in real-time if enough data was collected in the area of the scan.
	Brush tool Used to trim/delete areas on the scan.
	Measurement tool Used to place points to measure distance.
	Auto-Realignment This feature enables the user to optimize alignment of scans, in preparation for finalization.

5.3.2 Using the Scanner Tip

Each scanner is delivered with three (3) reusable tips, that can be sterilized in an autoclave up to 250 times.

1. Attach the tip with the mirror side facing downward. Firmly press the tip onto the scanner until you hear it lock into place.

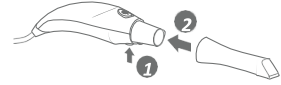

2. Detach the tip by pressing the button located on the bottom of the handpiece (1) while pulling away from the scanner (2).

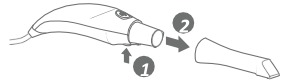

3. Rotate the tip 180 degrees, if you wish to make maxillary scanning more comfortable.

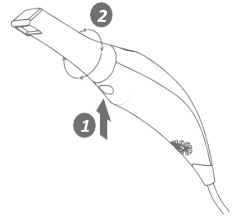

IMPORTANT: To avoid scanning errors, make sure the scanner tip clicks securely into place

4. For ease of use, hold the Heron™ IOS handpiece as shown.



5.3.3 The Scanning Live View

The **Live View** window in the lower left displays what the Heron™ IOS Scanner is actually seeing. 3D reconstruction of the scan is displayed in the middle of the screen.

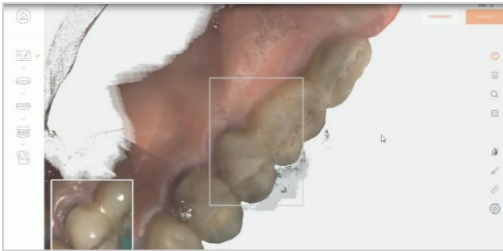

If the scanner loses connection with the reconstructed image, the Live View perimeter frame will be displayed in red.

Return the scanner tip to an already scanned section to resume the scan.

NOTE: You can continue to the next scanning area or pause the scanner at any time during the Scanning process without leaving the scanning workflow.

2D image Capture

During the scan process, press the "C" key on your keyboard to take and store 2D images automatically. 2D images are displayed in thumbnail format in the bottom left-hand corner of the screen.

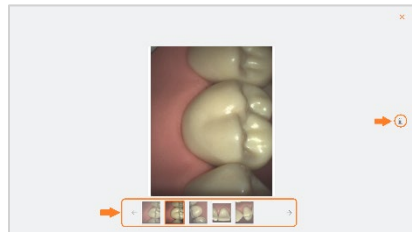

- Click on a thumbnail image to view the selected photo in more detail.
- Delete unwanted images by selecting them and clicking on the delete/bin icon as shown.

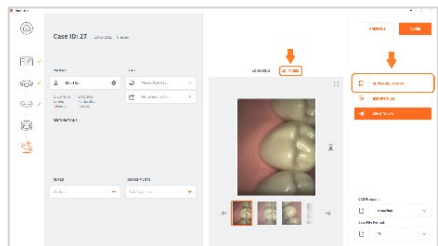

In the final **Order Form** window, you can consult photos taken during the scan by clicking on the **2D IMAGES** button.

5.4 Default Scan Workflow

Before launching a scan, make sure the Heron™ IOS Scanner is correctly connected to the computer and the HeronClinic™

Scanning Tips

Always take care when scanning to:

- Stay in contact with or close to the teeth (recommended distance from tip to tooth is 0-12 mm)
- Scan slowly and smoothly, to avoid interrupting the 3D reconstruction (minimum 1 second per tooth)
- Keep teeth in the center of the field of view
- Avoid scanning lips, cheeks, tongues, gloves, etc.
- Do not hesitate to reset the scan if necessary

Begin your scan by starting on the arch of chosen restoration. If you have selected to scan the antagonist, you may start by scanning either arch.

5.4.1 Scanning the Maxillary Arch



To make the scanning process **more comfortable** for maxillary scanning, you may remove the tip by pressing the button (1) located on the bottom of the handpiece and rotating the scanner tip 180 degrees (2).

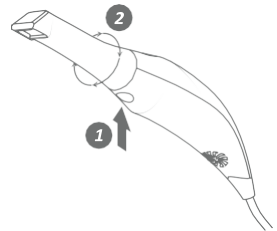

Recommended Maxillary Scan Path

When scanning the Maxillary arch, we recommend you scan in the following order:
1. Occlusal – 2. Buccal – 3. Palatal



IMPORTANT: Before use, the scanner's removable tip must be sterilized using an autoclave. See below: Section 7.2 **Cleaning and Sterilization of Tip.**

1. Scan the Maxillary Occlusal area

Occlusal Surface

First scan the **OCCLUSAL surface** from molar to molar, ensuring full occlusal surface is captured for all molars and premolars.

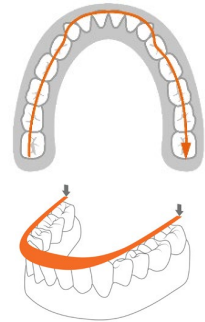
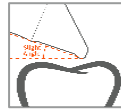

This initial path will drive the cross-arch accuracy of the scan, so always **Stay flat on the teeth**. It may be useful to angle the scanner slightly when you come to the incisor and canine teeth.

2. Scan the Maxillary Buccal area

- i. Scan the **BUCCAL** area from molar to center line on **LEFT side**, ensuring the connection of surfaces:
 - Scan with 45° angle to get part occlusal + part buccal
 - Scan with 90° angle to get last part of buccal

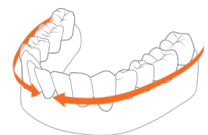
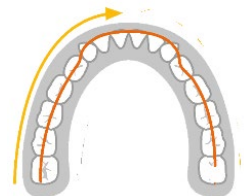
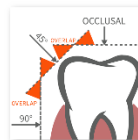
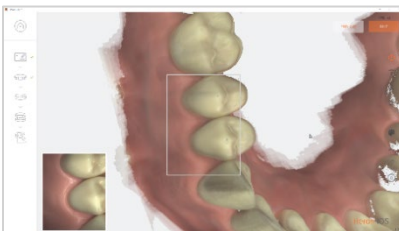

- ii. Scan **gum 3-4mm** in molar/pre-molar area **on LEFT side**.
- iii. Scan **BUCCAL** area from molar to center line on **RIGHT side**, ensuring the connection of surfaces:

- Scan with 45° angle to get part occlusal + part buccal
- Scan with 90° angle to get last part of buccal

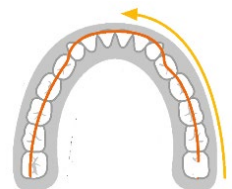
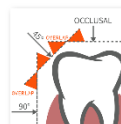

iv. Scan gum 3-4mm in molar/pre-molar area on **RIGHT** side

3. Scan the Maxillary Palatal area

Scan the **PALATAL** area from molar to molar, ensuring the connection of the surfaces (overlap):

- Scan with 45° angle to get part occlusal + part palate
- Scan with 90° angle to get last part of palate

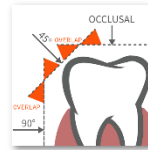
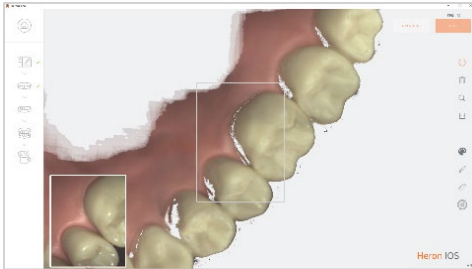

Processing Data

When the scan is complete:

- Turn the scanner off using the **Start/Stop button** on the handle of the scanner.

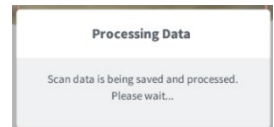

The Heron software will process the Maxillary scan data before moving on to the next phase of the Scan Workflow.

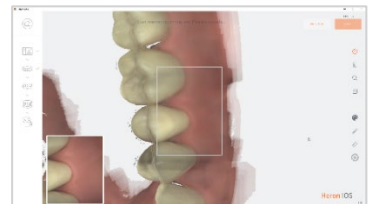

If scanning both arches:

- Select the **Mandibular** arch next in the **Scan Workflow Menu**.



5.4.2 Scanning the Mandibular Arch

Repeat the same scanning strategy as above for the **Mandibular** arch.

Due to the specific environment of the mandibular arch, it is recommended you follow the following scan path:

Recommended Mandibular Scan Path

When scanning the Mandibular arch, it is recommended you scan in the following order:

- 1. Occlusal – 2. Lingual – 3. Buccal.**

When the scan is completed, the **Mandibular** icon is highlighted in the left-hand **Scan Workflow Menu**.

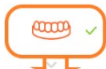

To advance to the Bite Alignment:



- iii. click **Next** or select the **Bite Alignment** icon in the **Scan Workflow Menu**.



5.4.3 Trimming scans

You can click the Brush tool in the right-hand Scan Tool Menu to trim and modify scanned images.

- i. Click and Hold [Ctrl] to select the surface area to be removed, then Delete.

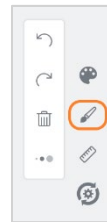
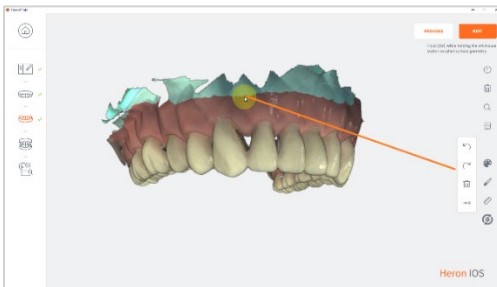

IMPORTANT: Trimmed data cannot be recovered.

- ii. Click OK to **Confirm Trim Operation**.

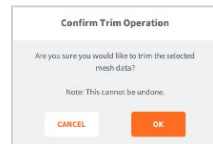

5.4.4 Using the Quality Map tool

The **Quality Map** tool allows the user to assess if enough data was collected in the area of the scan.



Be careful not to over-scan in an effort to recover extra data: it is recommended you reset the scan and do it again if the result is not satisfactory.



5.4.5 Bite Alignment

The Heron™ IOS enables you to carry out **Automatic Bite Alignment** based on the previously scanned Maxillary and Mandibular arches.

Note: When you select Bite Alignment, allow a few seconds for the arch scans to load.

1. Carrying Out An Automatic Bite Alignment

Scan Molar/Pre-Molar Segments

For the HeronClinic™ to automatically recognize the Mandibular and Maxillary arches:

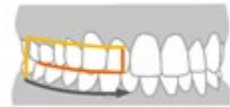

- **Scan a 3-4 teeth and 3-4mm gum segment on BOTH the LEFT side and on the Right side of the molar/pre-molar region in Occlusion.**
 - i. In the first pass scan the central molars capturing both mandibular and maxillary teeth.
 - ii. Then scan only the Maxillary molars and gingiva.

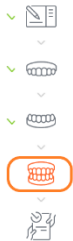

Note: In the event of a quadrant scan, you will be asked to scan only the side of the quadrant. When doing full arch scans, you will be prompted to scan bilateral.



For a better scanning experience, it is recommended to **first position the scanner in the fully open patient mouth** and then ask the patient to perform a bite.

Once the scanned bite segment is locked, the initial scan is overlaid and a green checkmark displays indicating you are finished scanning that arch.

- iii. Repeat for the opposing side.

Based on the left and right scanned bite segments, the Heron™ IOS will automatically reconstruct the alignment of the full Maxillary and Mandibular arches.

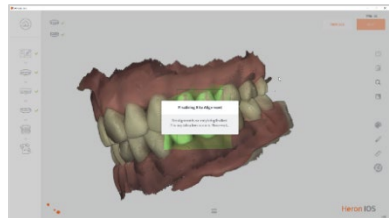

Note: The **Automatic Bite Alignment** may take a minute or two to process.

When **the Automatic Bite Alignment** is completed, the 3D reconstructed image is displayed as shown.

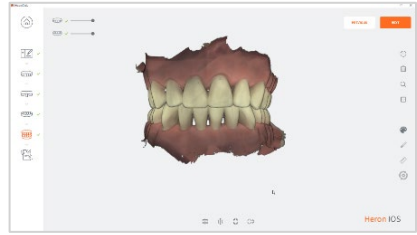

Manual Bite alignment

2. Carrying Out A Manual Bite Alignment



The **Manual Bite Alignment** tool enables you to **manually** select specific location points on the Maxillary and Mandibular arches. This can be useful if the Auto-Alignment is unsuccessful, due to insufficient data.

To Carry out a **Manual Bite Alignment**:

A. Align Mandibular-Paired Points

1. Click on the **Manual Alignment** icon in the Bite Alignment tools menu at the bottom of the Bite Alignment window.
2. For the HeronClinic™ to recognize the previously scanned Mandibular and Maxillary arches, **scan a 3-4 teeth and 3-4mm gum segment** on the **LEFT** side molar/pre-molar region in Occlusion.

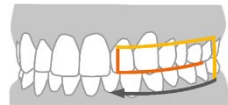

You will be prompted to select a mandibular-paired point on the bite scan segment.

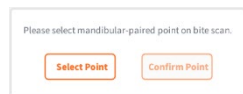

3. Click **Select Point** and choose a point on the mandibular arch of the **LEFT** side bite scan.



Choose an easily identifiable surface, without dense image complexity. This will make it easier for the software to recognize the selected position.

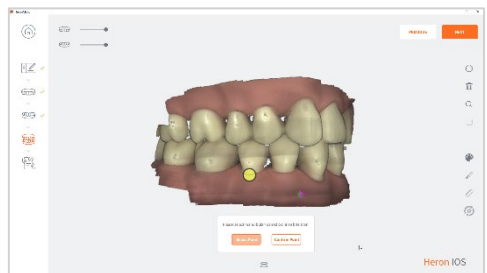

4. When you have positioned the marker, **HOLD [Ctrl] and click:** a yellow dot will indicate the selected mandibular-paired point.

5. Click **Confirm Point**.

The bite scan segment and the selected mandibular-paired point is displayed automatically in the top right-hand of the screen.

You will be prompted to select the corresponding paired point on the mandibular scan.

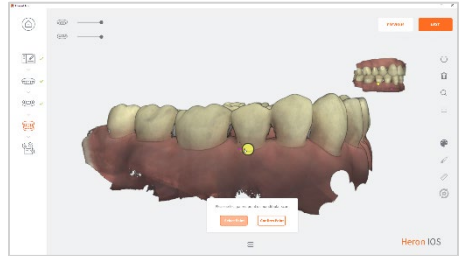

6. As before, click **Select Point**, **HOLD [Ctrl]** and click: a yellow dot will indicate the selected mandibular-paired point.

7. Click **Confirm Point**.

You will be prompted to select a maxillary-paired point on the bite scan.

B. Align Maxillary-Paired Points



Note: The Heron™ IOS software calculates the matching position based on recognizable surrounding surfaces and not on the specific point you have chosen, so you do not need to worry about replicating the exact position.

8. Click **Select Point** and choose a point on the maxillary arch of the LEFT side bite scan segment.

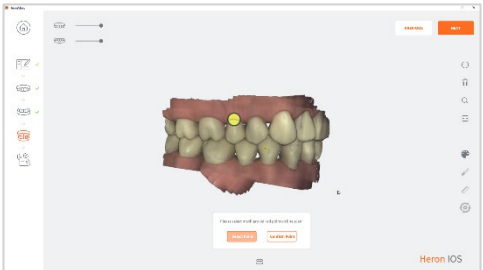

9. When you have positioned the marker, **HOLD [Ctrl]** and click: a yellow dot will indicate the selected maxillary-paired point.

10. Click **Confirm Point**.

The bite scan segment and the selected maxillary-paired point is displayed automatically in the top right-hand of the screen.

You will be prompted to select the corresponding paired point on the maxillary scan.



11. Click **Select Point** and choose a point on the maxillary arch of the LEFT side bite scan segment.
12. When you have positioned the marker, **HOLD [Ctrl] and click:** a yellow dot will indicate the selected maxillary-paired point.
13. Click **Confirm Point** to complete the manual alignment for the LEFT side.

C. Scan a molar/pre-molar bite segment on the opposing side

When you have finished manually aligning one side of the bite, you will be prompted to scan the opposing side.

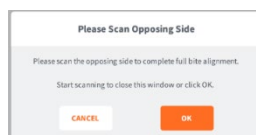

14. Scan a **3-4 teeth and 3-4mm gum segment** on the RIGHT side **molar/pre-molar region in Occlusion**.
15. Carry out the same procedure as described above in **steps 1-13**.

5.4.6 Auto-Realignment

Once you have carried out the Bite Alignment in the Heron™ IOS Scan Workflow, you can use the Auto-Realignment feature to optimize the scans.



Click on the **Auto-Realignment** icon in the **Scanning Tools** menu.

You will be prompted to confirm the optimization.

Click **OK** to launch the Auto-Realignment optimization.

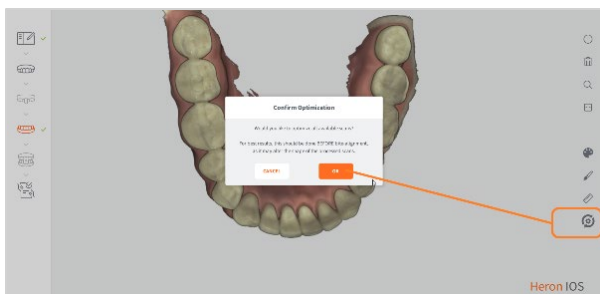
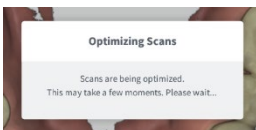

NOTE: The auto-realignment may take a few minutes.

5.4.7 Using Bite Alignment Tools

When you have successfully completed the Bite Alignment for your patient, you can use the **Bite-Alignment tools** to visually inspect the quality of the alignment scans.

The Bite-Alignment Tool menu is displayed below the 3D reconstructed image of the bite alignment.

Occlusion Distance Map



To visually check the clearance distance between the maxillary and mandibular arch scans:

- i. Click on the Occlusion Distance Map icon in the Bite Alignment Tool menu.
- ii. Adjust the color map by dragging the visual slider to the desired value.

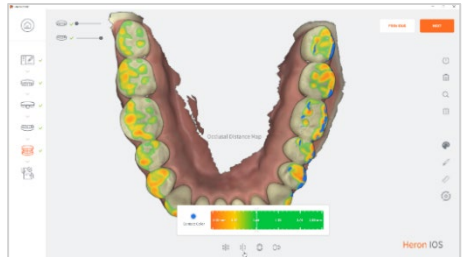

Open Jaws

You can use this tool to open the jaws after the bite alignment, to better inspect your scans.

Swap Jaws

Allows the user to swap jaw scans (in case lower was scanned instead of upper or vice versa).

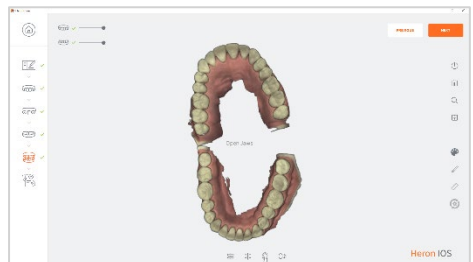

5.4.8 Finalizing A Patient Case



When you have finished scanning and alignment operations:

1. Click on the **Finalizing** icon in the Scan Workflow menu or click **Next**:

This will open the Case Finalization page.

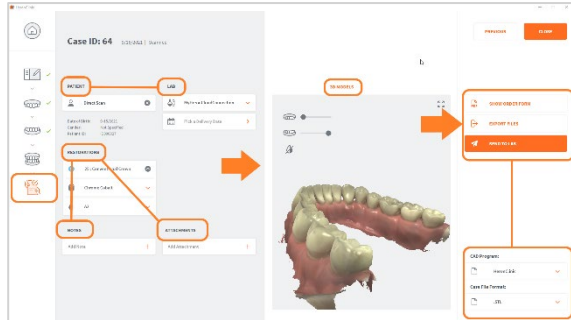

HeronClinic™ Case Information & Settings

Settings	Description
Patient	Patient ID
Lab	Lab connection configured in HeronCloud™ and requested delivery date (via interactive lab calendar).
Restorations	Restorations specified in Case Setup (Order Form).
Notes/Attachments	Relevant patient dossier details and documents.
Export Files	You can specify a default Case Export folder in systems settings: Case Export Path .
Show Order Form	Displays Order Form in PDF format.
CAD Program	CAD program used.
Case File Format	Case File Format
Send To Lab	This uploads the case files and order form to the selected lab via the HeronCloud™ connection configured for this lab. The lab will receive an automatic email notification from HeronCloud.

2. Verify Patient and Restorations information, and select the desired lab connection you have already configured in HeronCloud.
3. Enter the desired delivery date (if connected, the lab's interactive calendar will display here to provide available dates).

You can preview 3D models and any 2D images taken in the preview window.

4. Specify file formats and lab export details.

If you configured a default lab connection in the HeronClinic™ system settings, the case files and order form will be sent to this lab.

5. Click **Send To Lab**: this uploads the case files and order form to the selected lab via **the HeronCloud™ connection configured for this lab**.

See below: [6.2 Configuring a Connection with a Lab in HeronCloud](#)

6. The lab will receive an automatic **email notification** from **HeronCloud**.

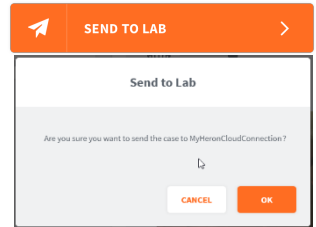

SEND TO LAB: HeronCloud™ Case View

When the lab clicks on the email notification of your order, it will open the relevant Case details in HeronCloud.

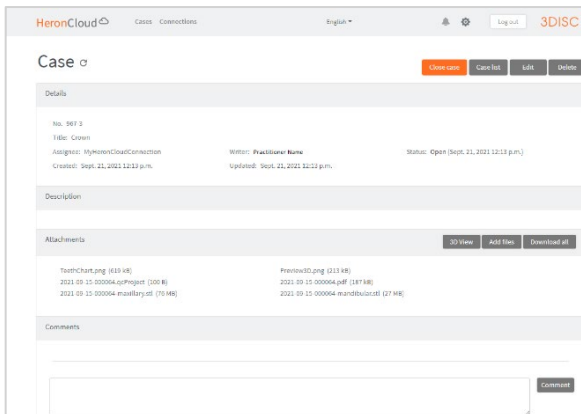

This provides the lab you have configured a connection to and to which you have sent an order via HeronCloud™ with secure access to all Patient Case files associated with the Order.

6. Communicating With Labs

To send orders from HeronClinic™ to labs via the HeronCloud™ platform, you will have to:

1. Link your HeronClinic™ account to the HeronCloud
2. Configure a connection with the lab in HeronCloud

Note: In HeronClinic™, you can also communicate directly with labs by exporting files to your computer and transferring them via a third party platform.

6.1 Linking a HeronClinic™ account to HeronCloud

Creating A HeronCloud™ User Account

To link your HeronClinic™ account to the HeronCloud:

1. Click on the System Settings icon in the HeronClinic™ Start screen.
2. In **User** system settings, click **Add or Edit Users** using the administrator account (HC).
3. Select **Use HeronCloud™** in the **Add or Edit Users** dialog box.

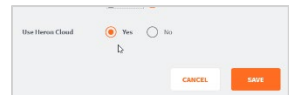
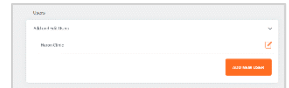
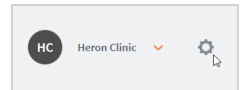

The **HeronCloud™ Login** window will open automatically, inviting you to **Login** or to **Create a New Account**.

4. Click **Create New Account**: in the dialog box **Fill** in the required fields (marked with a red *) and click **Create**.

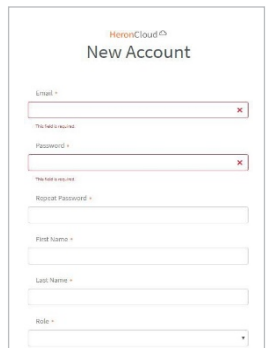

An email will be sent to confirm the email address.

5. Click the confirmation link to access the **HeronCloud™ Sign In** page.
6. Select a language in the scroll down menu.
7. Enter your Admin account email address and password to login to the HeronCloud™ platform.

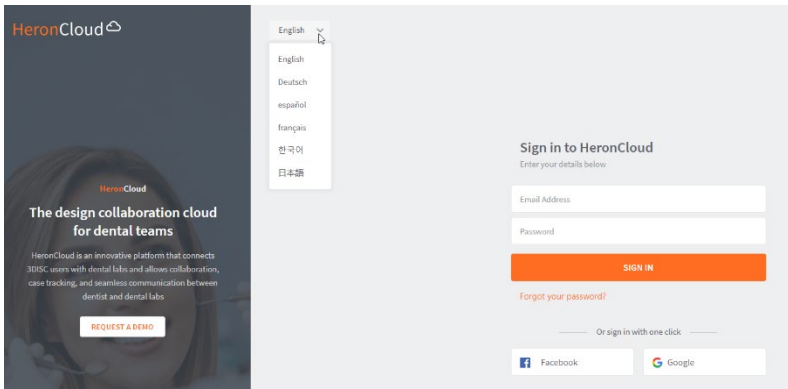

6.2 Configuring a Connection with a Lab in HeronCloud

When you have created a HeronCloud™ account and are logged in, you can now configure connections with the labs of your choice.

Adding a lab connection

To create a connection with a lab:

1. Click **Connections** in the HeronCloud™ interface.
2. Click **Add Connection**.
3. In the New Connection dialog box, enter the Connection email, Alias (optional) and Message.
4. Click **Send**. A request email is sent to the lab inviting it to accept the connection.
5. Click **Connections** to view connection status or to add another lab connection.

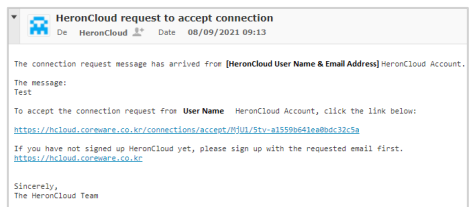
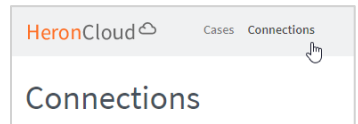

No.	Alias	Name	Email	Institution	Status	Delete	New Case
3	User Name		UserName@lab.com		Waiting for approval Round	×	
2	User Name		UserName@lab.com		Waiting for approval Round	×	
1	MyHeronCloudConnection		UserName@lab.com	3Disc	Accepted	×	

The status of your **Connection Request** is displayed: **(Accepted/Waiting for approval)**

Selecting Default Upload Settings in HeronClinic

When you have configured your HeronCloud™ account and added lab connections, you can select a **default lab connection** in HeronClinic™ to transfer files to, via your HeronCloud account:

1. Click HeronClinic™ **Settings** icon.
2. Scroll to **Upload Settings**.

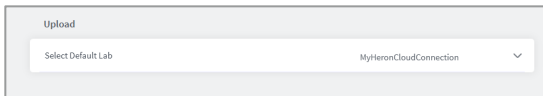

3. Click **Select Default Lab**.

6.3 Managing Case Details in HeronCloud

To access a patient case in HeronCloud:

1. Click **Cases** in the HeronCloud™ Startscreen.
2. Click on the Case **Title** from the list of cases.

The Case window displays Patient Case details and provides access to all files and information associated with the case.

In the Case details window, you can:

- Edit, add files to, or delete a Case
- Close or Reopen a Case
- View associated 3D elements

- Download all files and information for a case

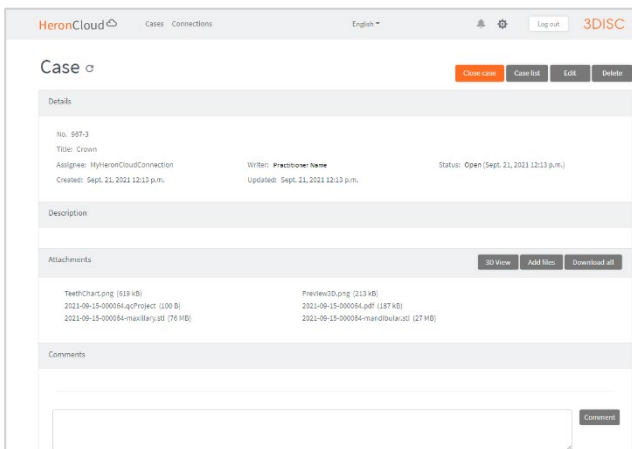

HeronCloud™ will provide the lab you have configured a connection to, and to which you have sent the order from HeronClinic, with secure access to all Patient Case files associated with the Order

6.4 Configuring HeronCloud Settings

System **HeronCloud™** settings can be configured for your HeronCloud™ User account.

To configure HeronCloud™ settings:

1. Click the **Settings** icon in the HeronCloud™ Start screen.

The following options are available in the scroll menu:

HeronCloud Settings	Description
Edit Profile	Opens the Account Management window, where you can enter and edit your HeronCloud account details.
Change Password	Opens the Change Password window.
Manage Group	Enables you to setup and manage Shared Groups.
Settings	Enable you to configure view settings, and push notification settings for your HeronCloud account.

2. Click on the desired setting to **Edit** your admin profile, **change password**, or **manage shared group settings**.

Configuring View & Notification Settings

To configure View & Notification settings for your HeronCloud account:

3. Click **Settings** in the scroll menu.

The following **View** and **Notification** options are available:

HeronCloud View & Push Notification Settings	Description
View Settings	Show 'Cases/Drafts' filter above case list
	Show 'Assignee' column in case list
	Use auto refresh
Push Notification Settings	Receive notification email when new case is published
	Receive notification email when case is modified
	Receive notification email when comment is added
	Receive notification email when comment is modified

4. Select the desired options.

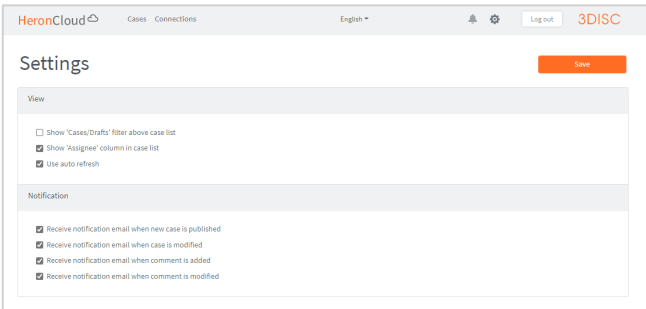

5. Click **Save** to save selected **View & Notification** settings.

7. Maintenance

7.1 Cleaning the Handpiece

The entire body, cord and base of the scanner must be wiped down using a Federal Environmental Protection Agency (EPA) approved disinfectant that is labeled and specified for tuberculocidal/ mycobactericidal activity. Do not use disinfectant on the nozzle.



NOTE: All components of the scanner (excluding the tips) must be wiped down and not sprayed. Avoid getting any moisture, alcohol or disinfectant inside the open scanner chamber.

Recommended and approved surface disinfectants:

- Birex Wipes: TB Claim= 10 minutes- 'Phenolic (Dual) Water-Based'
- Prospray Wipes: TB Claim=10 minutes- 'Phenolic (Dual) Water-Based'
- Cavicide Wipes: TB Claim=3 minutes- 'Phenolics (Dual) Alcohol-Based'
- DisCide ULTRA Wipes: TB Claim=1 minute- 'Phenolics (Dual) Alcohol-Based'
- Maxiwipe Germicidal Cloth: TB Claim=5 minutes- 'Phenolics (Dual) Alcohol-Based'
- Ster 1 Plus: TB Claim=5 minutes- 'Quaternary ammonium and Alcohol-Based'

7.2 Cleaning and Sterilization of Tip



NOTE: The included tips must be autoclaved prior to use as they do not come pre-sterilized.



NOTE: Ensure that the surface of the mirror does not show residues, smudges, scratches, or any damage, as this would affect the performance of the device.

Step-by-Step Procedure

Step 1: Clean the tip with soapy water, ensuring that the mirror is clean and free of smudges, stains, or any residue. Avoid using abrasive cloth materials as this will scratch the mirror.

Step 2: After drying the tip exterior, carefully dry the interior and mirror with lint free wipes ensuring you do not scratch the surface. The mirror should be free of any noticeable debris or water spots.

Step 3: Insert and seal the tip into a sterilization pouch. Make sure the seal is airtight. Each tip should be packaged individually.

Step 4: Sterilize the wrapped tip in a steam autoclave at following parameters:

- 132°C (270°F) at 4 minutes, or
- 134°C (273°F) at 4 minutes, or
- 121°C (250°F) at 45 minutes

Step 5: Ensure the dry cycle is complete prior to removing the tip from the autoclave. If the pouch is damp with moisture, proper sterilization cannot be guaranteed.

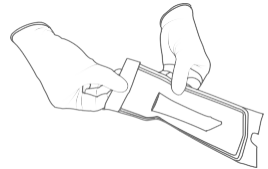

WARNING: Always autoclave the tip wrapped in a sealed sterilization pouch; failure to do so will result in permanent stains on the mirror.



NOTE: Tips should not be placed in an ultrasonic cleaner or any cold sterile solutions. The sterilant solutions will leave a sticky residue or film on the mirror when drying.



WARNING: Do not autoclave the handpiece of the device.



WARNING: Do not remove the pouch before the sterilizer completes its full dry cycle. If the pouch is wet or has any signs of moisture, this can potentially leave water spots on the mirror which can affect image quality during scanning.



WARNING: Use extreme caution when cleaning the mirror as it is very delicate and is prone to scratching.

7.3 Disposal

The Heron is an electrical device with electronic components inside and should be disposed of in accordance with local environmental laws and regulations.

7.4 Calibration

The Heron™ IOS is calibrated in the factory and therefore does not require calibration when installed.



WARNING: General prohibition indication. The functionality of the system can be destroyed in the case of incorrect use. If unauthorized changes have been made to the delivered system and accessories, the warranty by 3DISC becomes void. 3DISC will not accept any responsibility or liability for the improper functioning of the product in such a case.

If the Heron™ IOS begins to have problems scanning and recognizing teeth models, contact your dealer or 3Disc support technician.

If the scanner cannot be recalibrated remotely, this may result in the system being returned for repair/ calibration. See [Section 9 Support, Warranty and Repair Service](#) for further info.

8. Safety Guidelines and Warnings

8.1 Warnings and Symbols



NOTE: Notes represent information that is important to know but which do not affect the functionality of the system.



WARNING: The functionality of the system will be limited in the case of incorrect use.

8.2 General Guidelines

- Do not spill liquids on the body of the device
- Never operate the device in a wet environment.
- Keep the device away from radiators and heat sources.
- Use the device only with the accessories supplied.
- Do not alter the device or open enclosures.



WARNING: General prohibition indication. The functionality of the system can be destroyed in the case of incorrect use. If unauthorized changes have been made to the delivered system and accessories, the warranty by 3DISC becomes void. 3DISC will not accept any responsibility or liability for the improper functioning of the product in such a case.

If any of the following conditions occur, unplug the device from the electrical outlet and contact authorized service personnel:

- The power cord or power adapter is damaged.
- The device has been exposed to water.
- The device has been damaged.
- The device does not operate correctly when the operating instructions are followed.

8.3 General Warnings

8.3.1 System Modification



WARNING: Modifying the system may result in physical injury to the patient and operator, and damage to the system.

8.3.2 Approved Software

The Heron™ IOS device is designed to operate with the HeronClinic™ software. See section 5 below for details.



WARNING: The Heron™ IOS scanner should only be used with approved, compatible software.

8.3.3 Equipment Failure



WARNING: In case of system malfunction or failure, you should:
Prevent any contact between the system and the patient.
Unplug the system from the power outlet and the computer.
Store the system away so it cannot be used by someone else.
Contact service personal.

8.4 Mechanical Hazards

8.4.1 Moving Parts



NOTE: All moving parts are inside handheld scanner so do not open the unit.

8.4.2 Dropped Equipment



WARNING: If the scanner tip is dropped, ensure that the mirror is not damaged and that it is not detached; if the tip is damaged it should be disposed of immediately. If the scanner handpiece is dropped or bumped, ensure that no part of the system is damaged as it could affect performance.

8.4.3 Base



NOTE: When not in use, always rest the handpiece on the Base. The Base may be mounted on the wall per provided instructions. Do not place the Base on a slanted surface. Place the cables (power cable and USB cable) where people cannot accidentally get caught in them and potentially damage the system.

8.5 Electrical Safety

8.5.1 Electrical Shock



WARNING: There is a risk of electrical shock when opening or attempting to open any part of the system; only qualified service personal should open parts of the system.

8.5.2 Stress on Cables



WARNING: Care should be taken not to apply unnecessary stress on the cables of the system, whether it is the power cable, the USB cable or the cable between the handpiece and the Base.



WARNING: Only use the power adapter supplied as a part of the system.

8.6 Eye Safety



WARNING: During operation, the system emits a bright, flashing light from its tip. Although the system complies with standard IEC 62471 (Photobiological safety of lamps and lamp systems), prolonged exposure to flashing light may result in discomfort, seizure or eye irritation.

8.7 Hygiene



WARNING: In order to maintain safety for the patient, wear surgical gloves when handling any parts of the system. Always ensure that the tip is mounted on the handpiece before inserting it into the mouth of the patient. Before using the system with a new patient, ensure that the system is disinfected, and the tip is sterilized.

8.8 During Systems Operation



WARNING: The Heron™ IOS system contains delicate optical and mechanical elements and therefore should be handled carefully. Do not drop, bump, or shake the handpiece or the tip. Always place the handpiece on the Base when not in use. Do not put stress on the cable connecting the handpiece to the Base. Do not submerge the handpiece or the Base in any liquid. Do not place the handpiece or the Base on wet or heated surfaces. Hold the handpiece with a firm grip when handling it.



WARNING: In order to prevent over-heating of the system, the ventilation opening at the bottom of the handpiece should never be obstructed.



NOTE: During operation of the system, the handpiece and the tip may get slightly warm; this is normal.

8.9 EMC Guidance and Declaration

WARNING: Portable RF communication equipment (including peripherals such as antenna cables and external antennas) should not be used within 30 cm of any part of the Heron™ IOS, including cables specified by the MANUFACTURER. Otherwise, performance degradation of this equipment may occur.

WARNING: Use of this equipment adjacent to or on other equipment must be avoided as it may result in improper operation. If this use is necessary, it is advisable that this and the other equipment be observed to verify that they are operating normally.

Heron™ IOS Performance: Under normal use, the Heron™ IOS should be transmit images to the laptop/notebook with the installed image manipulation software and the video stream is visible in the bottom left corner of the screen. If not used

properly, there may be loss of transmission of image information or slow transmission temporarily.

Accessories

WARNING: Only use 3DISC approved accessories. Not using 3DISC approved accessories may result in deterioration of performance.

Accessory	3DISC Part Number
USB 3.0 Cable	IOS-CP-00-043
AC/DC Power Adapter	IOS-CP-00-088

Heron™ IOS is intended for use in a professional healthcare setting with electromagnetic environment specified below.

Electromagnetic Emissions

Emissions Test	Compliance	Electromagnetic Environment Guidance
RF Emissions CISPR 11	Group 1, Class A	Heron™ IOS uses RF energy only for its internal function. Therefore, its RF emissions are very low and are not likely to cause any interference in nearby electronic equipment.
Harmonic emissions IEC 61000-3-2	Class A	
Voltage Fluctuations/Flicker Emissions IEC 61000-3-3	Complies	Heron™ IOS is suitable for use in all establishments, including domestic establishments and those directly connected to the public low-voltage power supply network that supplies buildings used for domestic purposes.

Electromagnetic Immunity

Immunity Test	Test Level	Compliance Level	Electromagnetic Environment Guidance
---------------	------------	------------------	--------------------------------------

Electrostatic discharge (ESD) IEC 61000-4-2	± 8 kV /Contact ± 2 kV, ± 4 kV, ± 8 kV, ± 15 kV /air	± 8 kV /Contact ± 2 kV, ± 4 kV, ± 8 kV, ± 15 kV /air	Surface should be wood, concrete, or ceramic tile. If floors are covered with synthetic material, the relative humidity should be at least 30%.
Electrical fast transient/burst IEC 61000-4-4	± 2 kV for power supply lines ± 1 kV for input/output lines	± 2 kV for power supply lines ± 1 kV for input/output lines	Mains power quality should be that of a typical professional healthcare facility environment.
Surge IEC 61000-4-5	± 0.5 kV, ± 1 kV line(s) to line(s) ± 0.5 kV, ± 1 kV, ± 2 kV line(s) to earth	± 0.5 kV, ± 1 kV line(s) to line(s) ± 0.5 kV, ± 1 kV, ± 2 kV line(s) to earth	Mains power quality should be that of a typical professional healthcare facility environment.
Voltage dips, short interruptions and voltage variations on power supply input lines IEC 61000-4-11	<5% UT (>95% dip in UT) for 0,5 cycle 40% UT (60% dip in UT) for 5 cycles 70 % UT (30% dip in UT) for 25 cycles <5% UT (>95% dip in UT) for 5 s	<5% UT (>95% dip in UT) for 0,5 cycle 40% UT (60% dip in UT) for 5 cycles 70 % UT (30% dip in UT) for 25 cycles <5% UT (>95% dip in UT) for 5 s	Mains power quality should be that of a typical professional healthcare facility environment.
Power frequency (50/60 Hz) magnetic field IEC 61000-4-8	30 A/m	30 A/m	Power frequency magnetic fields should be at levels characteristic of a location in a typical professional healthcare facility environment.
Radiated RF IEC 61000-4-3	Table 9 in IEC-60601-1-2 2014	Table 9 in IEC-60601-1-2 2014	Portable and mobile RF communications equipment should be used no closer to any

<p>Conducted RF IEC 61000-4-6</p>	<p>3V 0.15-80MHz 6V in ISM bands between 0.15 MHz and 80 MHz 80% AM at 1KHz</p>	<p>3V 0.15-80MHz 6V in ISM bands between 0.15 MHz and 80 MHz 80% AM at 1KHz</p>	<p>part of the Heron™ IOS system, including cables, than the recommended separation distance calculated from the equation applicable to the frequency of the transmitter. Recommended separation distance:</p> $d = \left[\frac{3.5}{V1} \right] \sqrt{P} \quad 150 \text{ kHz to } 80 \text{ MHz}$ $d = \left[\frac{3.5}{E1} \right] \sqrt{P} \quad 80 \text{ MHz to } 800 \text{ MHz}$ $d = \left[\frac{7}{E1} \right] \sqrt{P} \quad 800 \text{ MHz to } 2.5 \text{ GHz}$ <p>where P is the maximum output power rating of the transmitter in watts (W) according to the transmitter manufacturer and d is the recommended separation distance in metres (m). Field strengths from fixed RF transmitters, as determined by an electromagnetic site survey, should be less than the compliance level in each frequency range. Interference may occur in the vicinity of equipment marked with the following symbol:</p> 
---------------------------------------	---	---	--

NOTE: UT is the A.C. mains voltage prior to application of the test level.

Recommended Separation Distances Between Portable and Mobile RF Communications Equipment and the Heron™ IOS System that is not Life-Supporting

Heron™ IOS System is intended for use in the electromagnetic environment in which radiated RF disturbances are controlled. The customer can help prevent electromagnetic interference by maintaining a minimum distance between portable and mobile RF communications equipment (transmitters) and the Heron™ IOS system as recommended below, according to the maximum output power of the communications equipment.















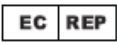
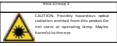

Rated maximum output power of transmitter W	Separation distance according to frequency of transmitter m		
	150 kHz to 80 MHz $d = \left\lceil \frac{3,5}{\sqrt{f_1}} \right\rceil \sqrt{P}$	80 MHz to 800 MHz $d = \left\lceil \frac{3,5}{\sqrt{f_1}} \right\rceil \sqrt{P}$	800 MHz to 2.5 GHz $d = \left\lceil \frac{7}{\sqrt{f_1}} \right\rceil \sqrt{P}$
0,01	0.12	0.12	0.23
0,01	0.38	0.38	0.73
1	1.2	1.2	2.3
10	3.8	3.8	7.3
100	12	12	23

For transmitters rated at a maximum output power not listed above, the recommended separation distance d in metres (m) can be estimated using the equation applicable to the frequency of the transmitter, where P is the maximum output power rating of the transmitter in watts (W) according to the transmitter manufacturer.

NOTE 1: At 80 MHz and 800 MHz, the separation distance for the higher frequency range applies.

NOTE 2: These guidelines may not apply in all situations. Electromagnetic propagation is affected by absorption and reflection from structures, objects and people.

8.10 Symbols on the Heron and TransportCase

Symbol	Description
	Manufacturer's trade name and address (ISO 15223-1)
	Date of manufacture (ISO 15223-1)
	Equipment Power On/Off (push/push)
	USB plug
	Warning, Consult Accompanying Documents
	General mandatory action manual
	General prohibition indication
	User Manual Reference
	Directive on Waste Electrical and Electronic Equipment
	Authorized Representative in the European Community
	Warning label for LED
	Non-ionizing electromagnetic radiation
	Direct Current
	Type(B) Level of protection against electric shock
	Consult operating instruction for use.
	European Conformity mark
	Prescription symbol
	Non-sterile (Scanner-Tips) (IOS-FPL-71-001)
	User manuals are available electronically at the link provided (3disc.com/support)



INMETRO Certification Mark



Ukraine Conformity Mark

9. Support, Warranty and Repair Service

9.1 Support

If you have questions about the software, please consult the manual and Help menu in the software. If you are experiencing issues with your software, please check the list of common issues provided in section 8.6 prior to contacting a dealer. It could be simply a question of a minor issue that can be fixed quickly. However, if you're still experiencing problems after following the recommendations in this section, then please contact the dealer where you bought the equipment.

9.2 Standard Warranty

3DISC warrants its non-consumable hardware products to be free from defects in materials and workmanship. The warranty covers the cost of parts and labor to repair the product.

Please keep the shipping container for future use. Products returned to the factory for repair should be properly packaged. To obtain warranty service, follow the procedure described in the Repair Service section. Failure to do so will cause delays and additional expense to the customer.

The warranty is valid when the product is used for its intended purpose and does not cover products which have been modified without written permission from 3D Imaging and Simulation Corp. Americas, or which have been damaged by abuse, accident or connection to incompatible equipment.

This warranty is in lieu of all other warranties, expressed or implied.

9.3 Repair Service

The Heron™ IOS cannot be serviced locally. In the event of a hardware malfunction, contact your dealer to arrange for a swap unit (same model or newer) so your unit can be replaced, and work can continue. Some testing might be needed in order to verify the Hardware/Software error or malfunction.

The company reserves the right to cease providing repair, maintenance, parts and technical support for its non-consumable hardware products five years after a product is discontinued.

9.4 Out of Warranty Repair Service

Out of warranty repair service is available in selected geographical locations. Contact the supplier for current terms and rates.

Issue	Recommendation
There's a memory full error message that pops up when the software is open.	Clear some space on the C Drive
The status in the Live view window is "Disconnected".	Check that you have external power to the Heron and that the USB cable is connected to a USB 3 Port.
Scanning is very slow.	Check that the Laptop is connected to an external power source.
The corners are cut in the live view window.	Check that the Tip is correctly mounted and when rotating it is locking in place with a click.
There is a red square in the scan window	Go back to a tooth that is scanned and start from there again
No images appear when scanned but everything else (e.g. live window image, sounds, FPS) works fine.	The scanner might need to be recalibrated. Please contact your local dealer for support.
There are spots on the Live view window.	Check and clean the mirror of the tip.
Where can I get the Heron™ IOS software and manuals?	Please find them in the Support section of 3DISC website.

We hope this User Manual was helpful to you.
For additional material and user information go to 3disc.com/support.

Heron™ IOS User Manuals
Heron™ IOS How-to Videos
Heron™ IOS Training Videos

3disc.com/support

3DISC



**3D Imaging and Simulations
Corp. Americas**

365 Herndon Pkwy #18
Herndon, VA 20170
United States

Tel: +1 703 430 6080

Tel: +1 800 670 0363 (Toll free)



3Disc Europe

10-12 RUE DE L'AMIRAL HAMELIN,
75116 PARIS,
France

Tel : +33 (0)1 42 25 73 98

Contact 3DISC

Info@3DISC.com

Contact support

support@3DISC.com